



ActivPanel Titanium

ActivPanel Cobalt *\*Select regions*

---

User Guide

## Table of Contents

<b>Introduction to Your ActivPanel .....</b>	<b>4</b>
<b>Power On with Proximity Sensors .....</b>	<b>6</b>
<b>Center Console .....</b>	<b>7</b>
<b>Remote.....</b>	<b>8</b>
<b>Unified Menu .....</b>	<b>9</b>
<b>Locker .....</b>	<b>10</b>
<b>Adjusting Brightness .....</b>	<b>11</b>
<b>Adjusting Volume .....</b>	<b>12</b>
<b>Palm Reject .....</b>	<b>13</b>
<b>Large Mode .....</b>	<b>14</b>
<b>More Settings .....</b>	<b>15</b>
<b>Connecting to the Internet .....</b>	<b>16</b>
<b>Turn Panel Speakers On or Off.....</b>	<b>18</b>
<b>Changing Your Wallpaper.....</b>	<b>20</b>
<b>Multi-Window Toolbar .....</b>	<b>21</b>
<b>User Profiles: Creating New Profiles .....</b>	<b>22</b>
<b>User Profiles: Adding Security.....</b>	<b>23</b>
<b>User Profiles: Guest Profile.....</b>	<b>24</b>
<b>Promethean Cloud Connect: Google Drive.....</b>	<b>25</b>
<b>Promethean Cloud Connect: Microsoft OneDrive.....</b>	<b>27</b>
<b>Promethean Whiteboard App .....</b>	<b>29</b>
<b>Promethean Capture App .....</b>	<b>30</b>
<b>Promethean Annotate App.....</b>	<b>31</b>
<b>Switching Sources.....</b>	<b>32</b>
<b>Power On Default Source.....</b>	<b>33</b>
<b>Promethean Timer App.....</b>	<b>34</b>
<b>Promethean Spinner App.....</b>	<b>35</b>
<b>Promethean Account .....</b>	<b>36</b>
<b>Promethean Screen Share App: Connecting Devices.....</b>	<b>37</b>
<b>Promethean Activities Player .....</b>	<b>43</b>

**Recent Apps .....44**

**Managing Apps .....45**

**Locating Apps .....47**

**Rearranging Apps .....48**

**Closing Apps .....49**

**Uninstalling Apps .....50**

**Accessing Content from Your USB and Downloading Files .....51**

**Creating Bookmarks in the Chromium Browser .....52**

**Connecting a Laptop to Your ActivPanel .....53**

**Connecting an ActivConnect OPS-G to Your ActivPanel .....56**

**Connecting a Promethean Chromebox to Your ActivPanel .....58**

**Help and Support .....60**

## Introduction to Your ActivPanel

Purpose-built for the classroom, the ActivPanel provides the most seamless, integrated, and interactive learning experience available. Packed with engaging and interactive tools, the ActivPanel helps you and your students make the most out of every instructional moment in the classroom.



The front of your ActivPanel features a center console, positioned for comfort and easy accessibility at a 30-degree angle. Use the Center Console to adjust the volume, access the Unified Menu, manage touch on/off and freeze, as well as selecting sources.



Your ActivPanel has a preinstalled Unified Menu that contains the most commonly used tools right at your fingertips. These tools include our beloved Whiteboard and Annotate apps, the ability to capture anything on your screen with Screen Capture app, easily switch sources between connected devices, and Screen Share for mirroring.



Best of all, the Unified Menu is accessible from the bottom, left, and right sides of the ActivPanel, to allow you seamless mobility and plenty of access for your students.

To locate all of your favorite apps, tools, files, and settings, in one location, select the Locker icon from the Unified Menu.

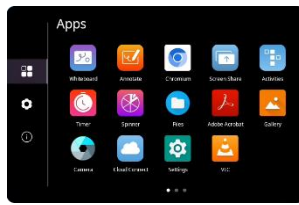

Our Classroom Essentials Apps are also preinstalled, and full of perfect supplements to your lessons, regardless of grade level or content area. These apps include the Timer, Spinner, Annotate, Screen Share, and Whiteboard. These apps were developed specifically in response to teacher feedback, and they are accessible from the Unified Menu or the Locker.



Additional features of your ActivPanel include Vellum writing technology, Wi-Fi and Bluetooth capabilities, dual proximity sensors for instant power on, 20 points of touch, simultaneous pen, touch, and palm erase, and bass-enhanced speakers.

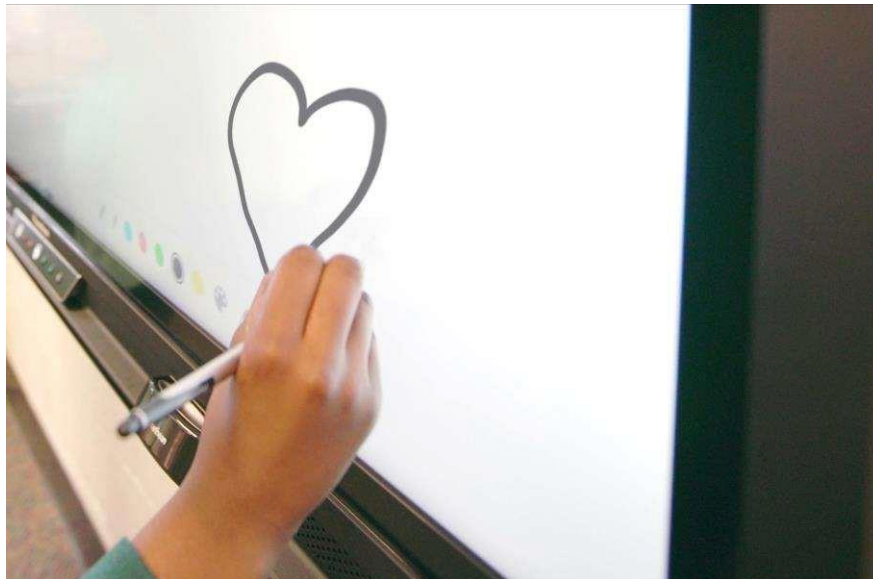

## Power On with Proximity Sensors

Dual proximity sensors on the front of the ActivPanel allow you to quickly power on your panel with a single touch.



As you enter the room and near the ActivPanel, the dual proximity sensors automatically begin the boot up process.



Proximity sensors remain powered on by default. You may also choose to reset the sleep and standby timers when motion is detected, or illuminate the screen when motion is detected.

You may disable the proximity sensors by accessing the **Settings gear icon**, then **Display**. Toggle the proximity sensor to **off**.

## Center Console

The ActivPanel has an ergonomic center console that sits at a comfortable 30-degree angle to provide quick and easy access to navigation buttons.



1. **INSTANT POWER ON:** When the proximity sensors detect a person near the ActivPanel, they immediately initiate the boot up process. Press the Power button once and the screen turns on in less than a second! Following this, once the panel goes into standby mode, you may tap anywhere on the screen to turn the ActivPanel back on.
2. **VOLUME:** The Volume buttons allow you to increase or decrease the audio coming from the bass-enhanced speakers.
3. **PROMETHEAN FLAME:** The Promethean Flame button opens the Unified Menu.
4. **FREEZE:** The Freeze button freezes the current image on the screen (when HDMI source selected).
5. **TOUCH:** The Touch button allows you to manage panel interaction by turning touch on or off.
6. **SOURCE:** The Source button allows you to switch between connected devices,

## Remote

The Promethean remote allows you to navigate your ActivPanel from anywhere in the classroom.



1. **INSTANT POWER ON:** Turn your ActivPanel on.
2. **NAVIGATE AND SELECT:** Use the arrows to navigate to the option of your choice. Press the checkmark to select your option. Also interacts with Google and PowerPoint slides. Allows navigation within panel settings, adjusts sliders and enable or disable toggles, and enables scrolling within the Chromium browser and other applications.
3. **VOLUME:** Use + to increase and - to decrease your ActivPanel's volume.
4. **UNIFIED MENU:** Use to access your Locker and Classroom Essential apps.
5. **SOURCE:** Use to switch to any device connected to your ActivPanel.
6. **BLANK SCREEN:** Use to instantly have nothing visible on the ActivPanel.
7. **FREEZE:** Use to freeze the current image, from HDMI connected device, on the screen



## Unified Menu

The Unified Menu is preinstalled and easily accessible from the bottom, left and right sides of the ActivPanel's screen. The Unified Menu provides quick access to Classroom Essential apps, the Locker and Sources.



1. **BACK:** The Back button returns you to the previous screen.
2. **LOCKER:** The Locker is a personal space for you to access Apps and Settings.
3. **USER:** User allows you to access, create, modify, and add security to user profile settings.
4. **HOME:** The Home button returns you to the home screen from any application.
5. **WHITEBOARD:** The Whiteboard app is an instant whiteboard with several annotation tools, math tools, concept maps, infinite space, and the ability to turn any content into a collaborative activity with our multi-user mode.
6. **CAPTURE:** Capture takes a snapshot of the current screen. Use it in its entirety, or crop it to best meet your needs. The image opens in Whiteboard for interaction with all of the Whiteboard tools.
7. **ANNOTATE:** The Annotate app floats on top of any device connected to your ActivPanel, providing you the ability to annotate on top of anything.
8. **SOURCE:** Source allows you to quickly access devices connected to your ActivPanel.
9. **SCREEN SHARE:** Screen Share allows any device (iPad, Chromebook, smart phone, laptop, etc.) to mirror to your ActivPanel.
10. **RECENT APPS:** Navigating between most recently used apps is simple. Select Recent Apps and choose the app you would like to interact with.
11. **HELP APP:** The Help app provides resources and support to assist you with getting started with your ActivPanel.

## Locker

The Locker is a personal space for you to access apps, files, and settings. You can access your **Locker** from any of the three **Unified Menu** locations.



There are three icons on the left side of the Locker: **Apps**, **Settings**, and **About this panel**.

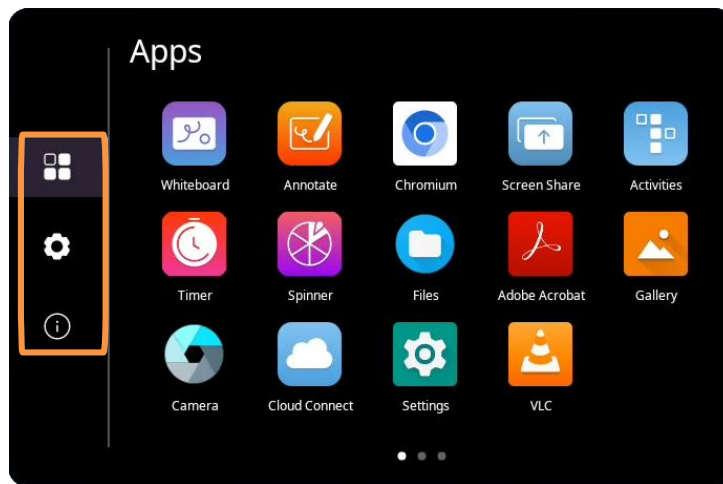

**Apps** allows you to access preinstalled Classroom Essential apps such as Activities, Annotate, Screen Share, Spinner, Timer, and Whiteboard, as well as any apps you have installed on connected devices such as an ActivConnect OPS-G or Promethean Chromebox.

Tap the **gear icon** to access Settings. In Settings, you may quickly change ActivPanel settings such as brightness or volume, and access more settings.

The **About this panel** icon will provide you details about your ActivPanel. This information may come in handy when communicating with your IT Administrator or Promethean Support.

## Adjusting Brightness

To adjust the brightness on your ActivPanel, select the **Unified Menu**, then tap **Locker**.



Choose the **gear icon** to access Settings. **Press and slide** the brightness bar forward or backwards until you achieve the desired brightness. This menu also appears when the volume is adjusted.

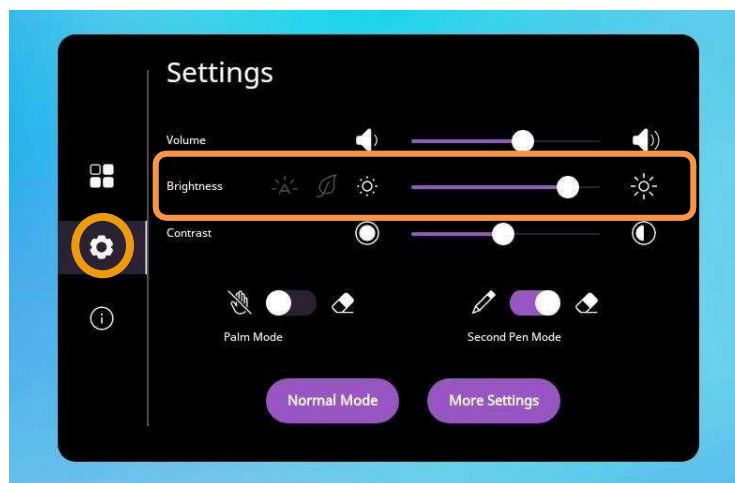

## Adjusting Volume

To adjust the volume on your ActivPanel, select the **Unified Menu**, then tap **Locker**.



Choose the **gear icon** to access Settings. **Press and slide** the volume bar forward or backwards until you achieve the desired level.

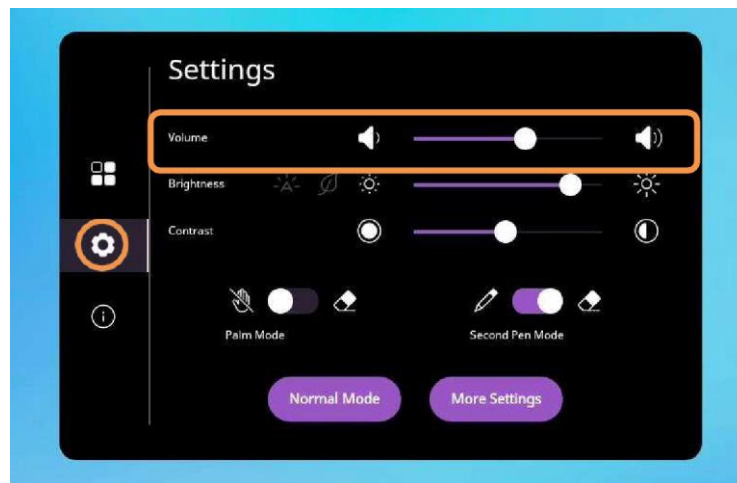

## Palm Reject

Turning Palm Reject on allows you to place your palm on your ActivPanel without activating the eraser. The eraser tool can then be activated by the physical eraser. To turn Palm Reject on, select the **Unified Menu**, then tap **Locker**.



Choose the **gear** icon to access **Settings**. **Toggle** to turn Palm Reject on.

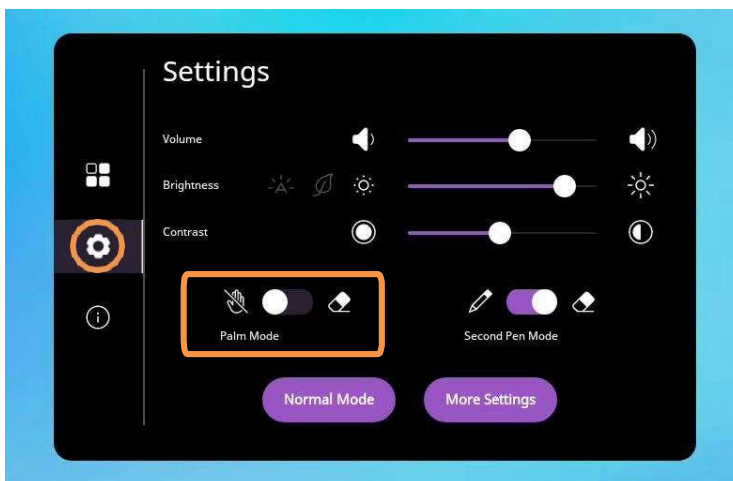

## Large Mode

Large Mode increases the size of the icons on the Unified Menu. To enable Large Mode, select the **Unified Menu**, then tap **Locker**.



Choose the **gear** icon to access **Settings**. Tap **Normal Mode**. The button will now read **Large Mode**.

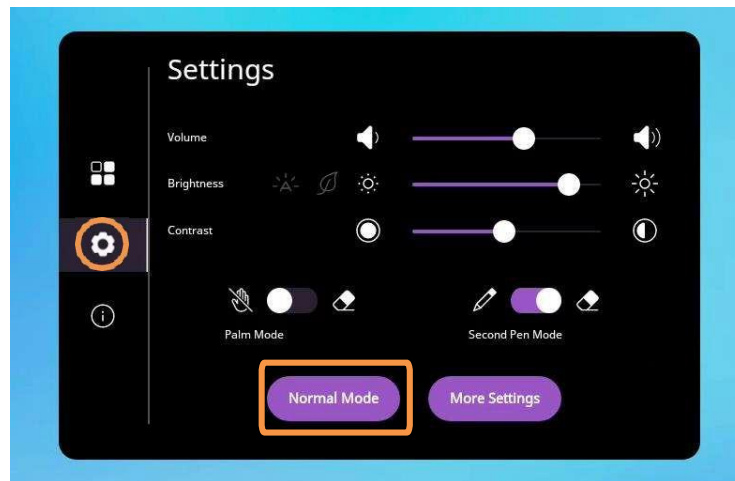

Now you may enjoy larger icons, no matter where you choose to access the Unified Menu.

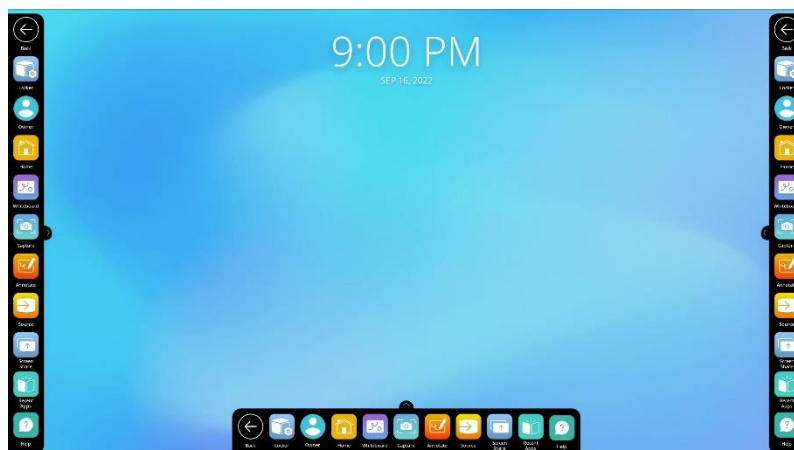

## More Settings

To access network connections, find information about your apps, and to fully customize your ActivPanel experience, you will want to visit More Settings. To access More Settings, select the **Unified Menu**, then tap **Locker**.



Choose the **gear** icon to access **Settings**. Tap **More Settings**.

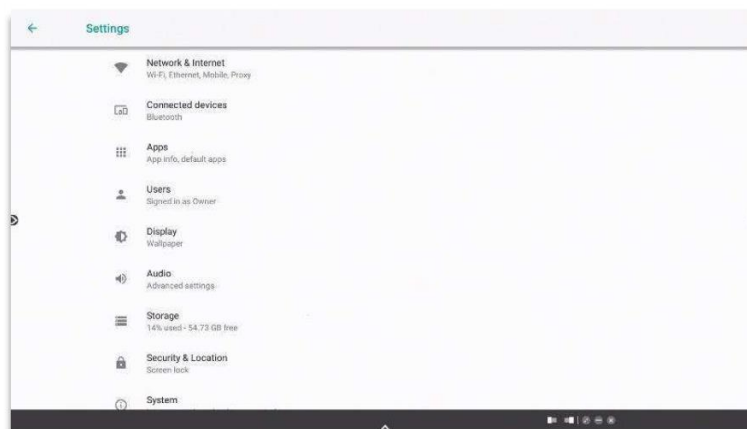
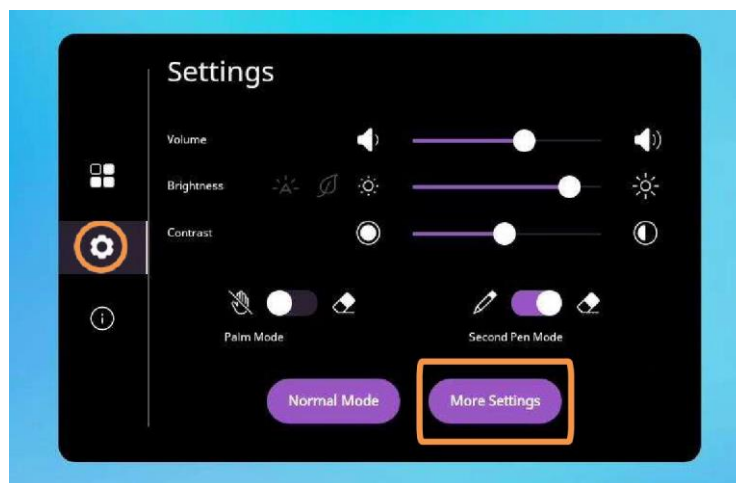

## Connecting to the Internet

To connect your ActivPanel to the internet, select the **Unified Menu**, then tap **Locker**.



Select the **Settings** icon. Tap **More Settings**.

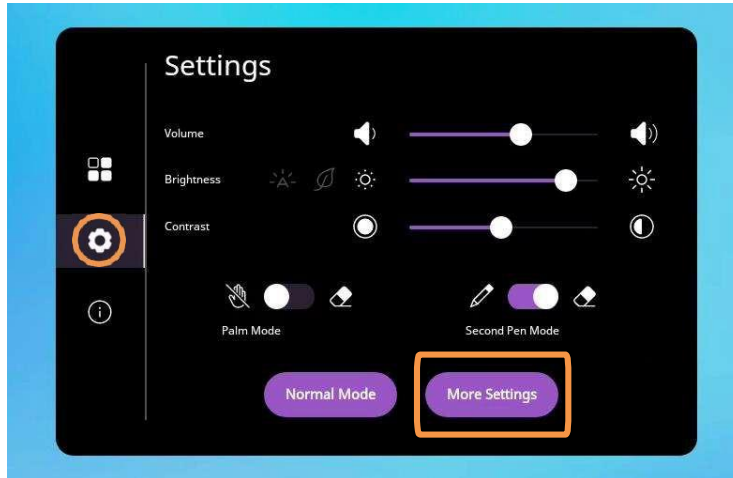

Select **Network & Internet**. If you have an Ethernet cable connected, this is where you can complete the process.

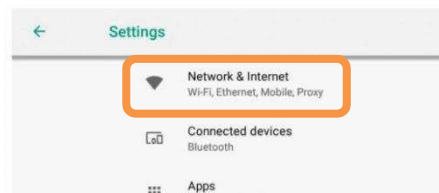

To connect to a wireless network, toggle the Wi-Fi switch **on**. Select your desired wireless network and input a password if necessary.

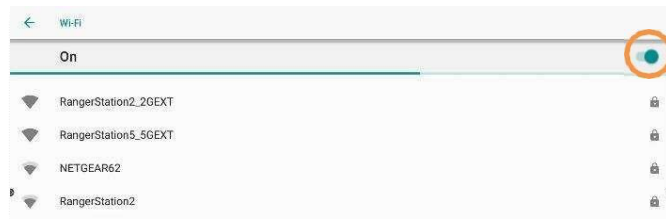

Once you have successfully connected, you will see a confirmation below the network name.





## Turn Panel Speakers On or Off

There may be instances in which you wish to disable your ActivPanel's speakers. To change this setting, begin by accessing your **Unified Menu**, then tap **Locker**.



Next, select the **gear** icon on the left to go to the **Settings** tab within your Locker. Choose **More Settings**.

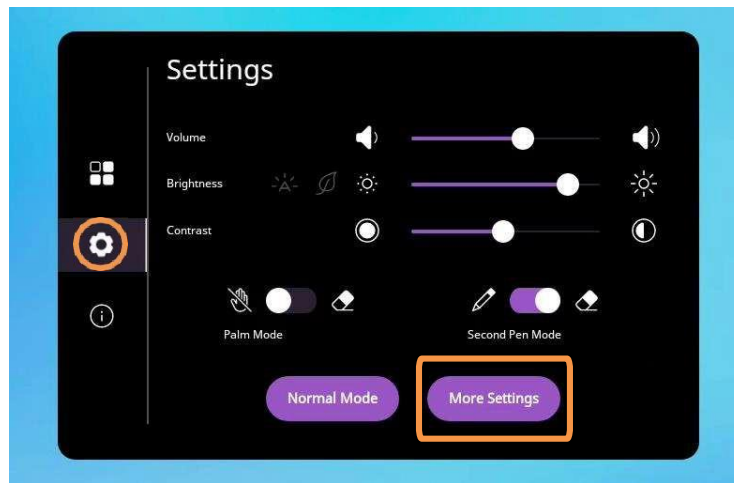

Within More Settings, select **Audio**.

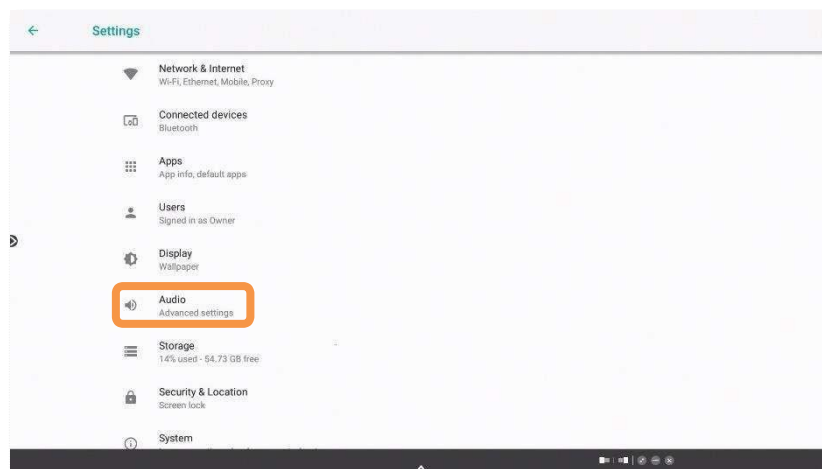

Toggle the panel speakers off or on to best meet your instructional needs. You may return to this setting at any time.

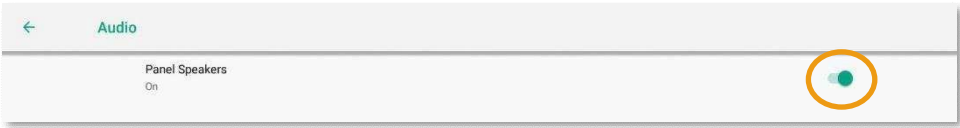

## Changing Your Wallpaper

There may be instances in which you wish to change the wallpaper on your ActivPanel's home screen. To do this, begin by accessing your **Unified Menu**, then tap **Locker**.



Next, select the **gear** icon on the left to go to the **Settings** tab within your Locker. Choose **More Settings**.

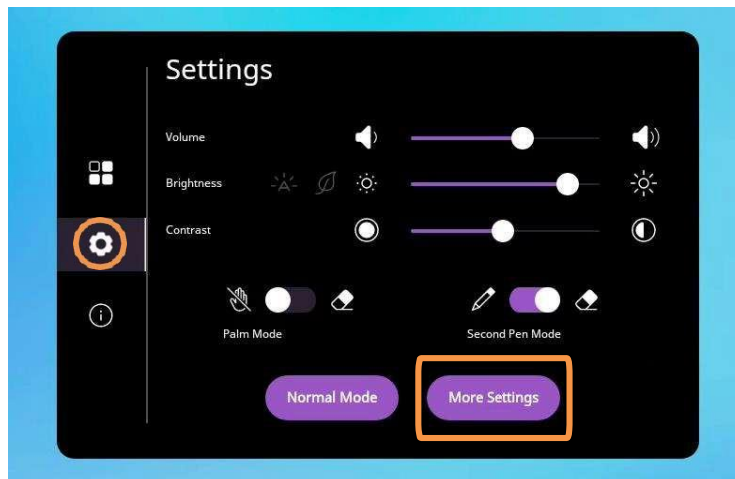

Within More Settings, select **Display**.

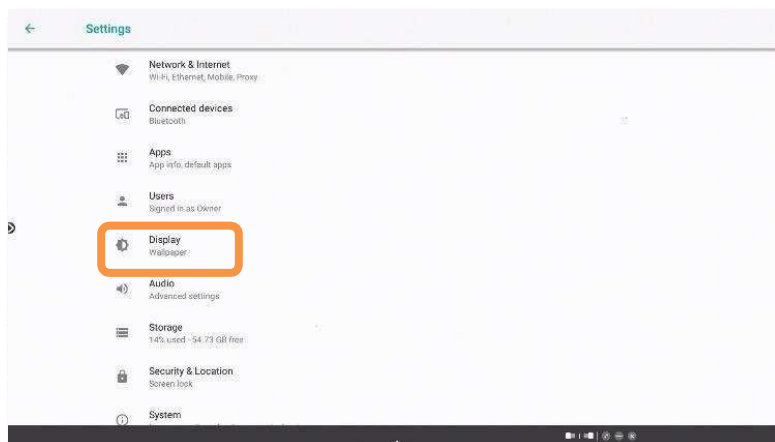

The image must first be saved to the panel's gallery either via the screen capture app or from a connected USB drive.

Choose **Wallpapers**. Tap **My Photos** in the bottom left corner to locate the image you wish to use for your new wallpaper.

Once you have chosen a new image, tap **Set Wallpaper** in the upper left corner. Next, choose **Home Screen**. The wallpaper is updated immediately. You may change it again at any time.

## Multi-Window Toolbar

The Multi-Window toolbar enables the ability to work in multiple windows simultaneously. When you see the Multi-Window toolbar at the bottom of a window, this indicates Multi-Window capabilities are in effect.



1 2 3 4 5 6

1. **SNAP LEFT:** Snap Left allows you to dock the window to the left side of the screen.
2. **SNAP RIGHT:** Snap Right allows you to dock the window to the right side of the screen.
3. **ENTER/EXIT FULLSCREEN:** The diagonal arrows allow you to enter or exit fullscreen mode. Tap the diagonal arrows once more to re-enter fullscreen mode.
4. **HIDE:** The Hide button allows you to hide the app. You may select **Recent Apps** from the Unified Menu to return to the app, or launch it again from the Unified Menu or Locker.
5. **CLOSE:** Tapping the **X** on the toolbar will close the app.
6. **SIZING HANDLE:** The sizing handle allows you to resize the window to best meet your needs. To access the sizing handle, press and hold on the gray multi-window toolbar, then drag up and release. You can do this from either fullscreen or half screen mode.

Here is an example of the Whiteboard and Chromium apps snapped to the left and right:

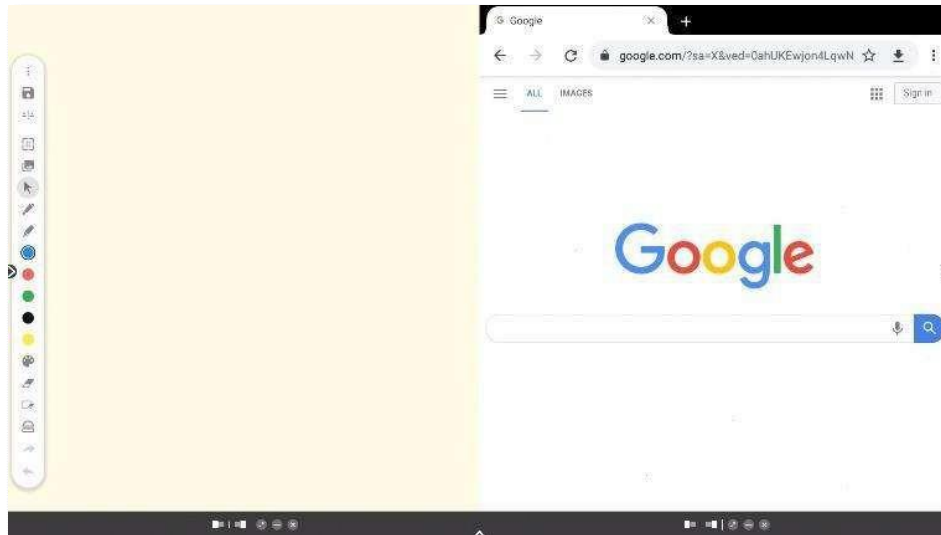

## User Profiles: Creating New Profiles

Your ActivPanel allows the panel owner to create new user profiles. This feature improves the workflow and enables more secure multi-user functionality on the panel. This can be handy if you are sharing your ActivPanel with colleagues, or for instances in which you have a guest teacher or substitute.

To access user accounts, select the **Unified Menu**, then tap **User**. In this case, it says Owner underneath, but different users may be created.



Select the **settings gear** icon. Select **You (Owner)** to change the Owner's name. Select the avatar to change the Owner's picture.



To add a new user, tap **+Add user**. You will be prompted with a short message. Tap **OK**. Each new user will need to set up their profile by selecting **Set Up Now**.

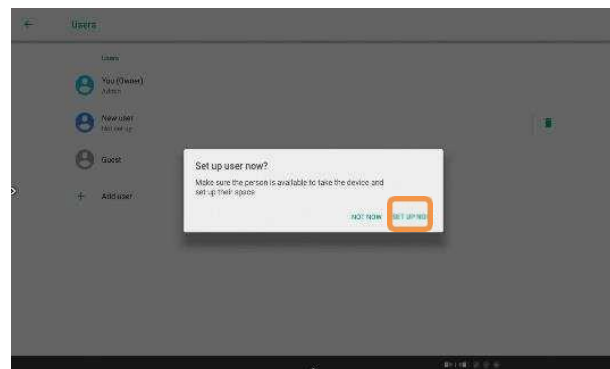
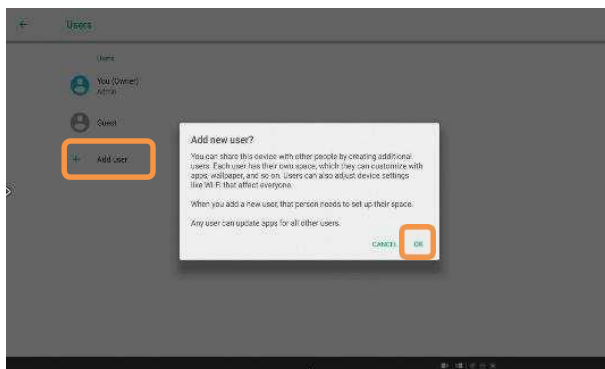

The New User is now signed in. The Owner icon in the Unified Menu now reads "New User." Select **New User**, then tap the **settings gear** icon. You may modify the name and image.

To switch profiles, select the **Unified Menu**, tap **User**, then select **Sign Out**. This returns you to the Sign-In Screen. Within the Owner's profile, select the **Unified Menu**, tap **User**, then the **settings gear** icon to manage user profiles, including adding new users or deleting users.

## User Profiles: Adding Security

Your ActivPanel has User Profiles that enable multiple educators to make the most of a single ActivPanel. To create a PIN or password for a user profile, select the **Unified Menu**, then tap **User**, which in this case reads **Owner**. Next, select the **lock** icon.



To lock your user profile, select **Screen lock**.

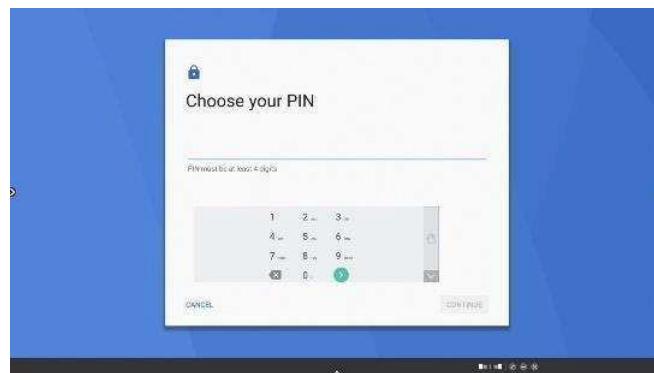

Choose between creating a PIN or a password. A PIN is numeric code between 4 to 16 digits, whereas a password can be a combination of alphabet characters between 4 to 16 digits. Depending on your selection, input your PIN or password. Select **Continue**. You will be prompted to confirm your PIN or password. Tap **OK**.

When you're returned to the Security & Location screen, your form of security now displays under Screen lock.

To sign out, select the **Unified Menu**, then **User**, and **Sign Out**. You will be returned to the Sign-in screen. When you select your profile again to sign back in, you will be prompted to enter your PIN or password.

To change or remove your PIN or password, sign in to your user profile. From the **Unified Menu**, tap **Locker**. Select the **Settings** tab, then **More Settings**. Tap **Security & Location**. Select **Screen Lock**. You will be prompted to enter your existing PIN or password once more. From here, select **None** to remove the security altogether, or tap **PIN or password** to change your pin or password. **Note** - a forgotten PIN or password cannot be retrieved.

## User Profiles: Guest Profile

Your ActivPanel Titanium has User Profiles that enable multiple educators to make the most of a single ActivPanel. The Guest Profile is ideal for instances in which a guest instructor or substitute is using your panel.

To begin, select **Guest** from the Sign-In screen.

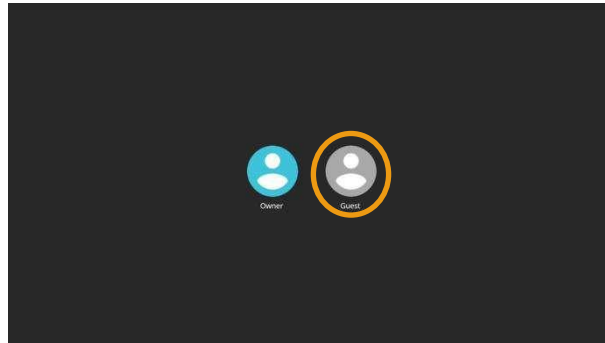

As a Guest, you will be able to utilize Classroom Essential Apps, access the web, and more. When your Guest session is complete, select the **Unified Menu**, then tap **User**. In this case, it is labeled *Guest*.



Select **Sign Out**.



You will be prompted to delete your session's information or save it for later. Guest session information includes local web data, local app data, and locally stored files.

Regardless of your choice, you will be returned to the Sign-In screen.



## Promethean Cloud Connect: Google Drive

Within a user profile, you can connect your Google Drive account to your ActivPanel using Promethean Cloud Connect. This allows you to easily access and save files and improves your workflow in the classroom.

To begin, select the **Unified Menu**, then tap **User**. Select the **cloud icon**.

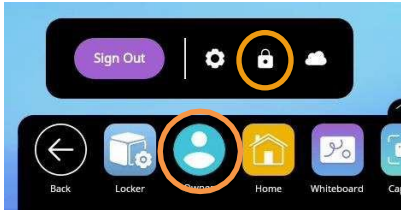

Next, choose between Google Drive or Microsoft One Drive. You may connect both if you wish.

You'll be prompted with a sign-in screen. Enter your email, then tap **Next**.

Enter your password, then tap **Next**.

Finally, to provide your ActivPanel with access to your Google Drive, select **Allow**.

You will see a small window displaying your connected Google Drive.

To manage your connected Google Drive, simply return to the cloud icon. Tap the **gear icon** to remove your account. Or tap **Add Account** for more options.

You may access files by selecting the **Unified Menu**, then tapping **Locker**. Within your Locker, locate and select the **Files** app. You may also access Promethean Cloud Connect from within your Locker.



Your **Google Drive** now displays on the left side of the window. Access images, PDFs, Promethean Whiteboard files, and more.

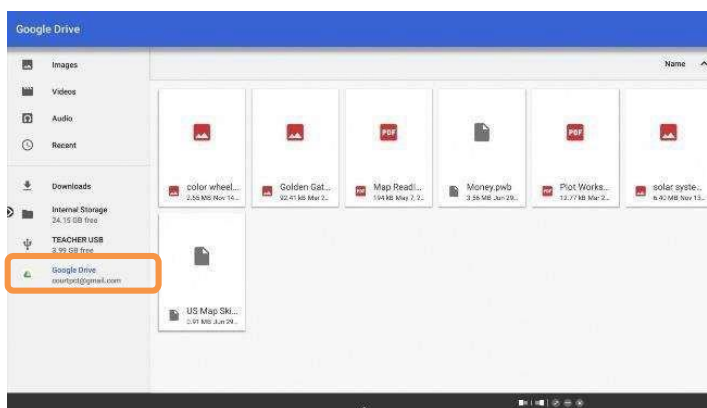

Easily save Promethean Whiteboard files to your connected Google Drive by selecting the **Menu**, then **Save As**.



To change the save location, you may need to select the **three horizontal lines** in the top left corner.

Then, select **Google Drive**.

Give your Whiteboard file a name, then tap the **green checkmark** on the keyboard

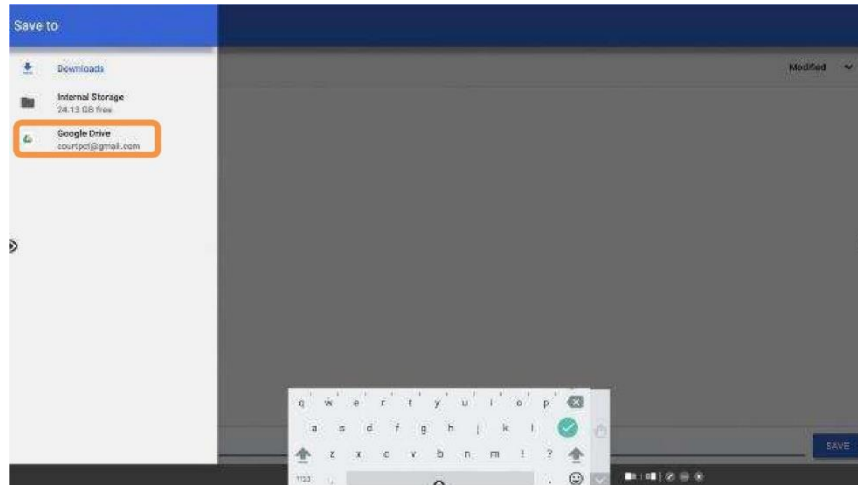

## Promethean Cloud Connect: Microsoft OneDrive

Within a user profile, you can connect your Microsoft OneDrive account to your ActivPanel using Promethean Cloud Connect. This allows you to easily access and save files and improves your workflow in the classroom.

To begin, select the **Unified Menu**, then tap **User**. Select the **cloud icon**.

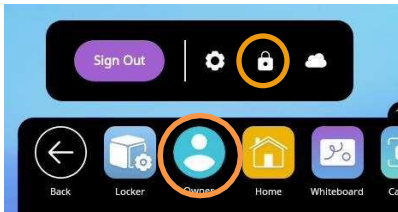

Next, choose between Google Drive or Microsoft One Drive. You may connect both if you wish.

You'll be prompted with a sign-in screen. Enter your email, then tap **Next**.

Enter your password, then tap **Sign In**.

Finally, to provide your ActivPanel with access to your OneDrive, select **Yes**.

You will see a small window displaying your connected OneDrive.

To manage your connected OneDrive, simply return to the cloud icon. Tap the **gear icon** to remove your account. Or tap **Add Account** for more options.

You may access files by selecting the **Unified Menu**, then tapping **Locker**. Within your Locker, locate and select the **Files** app. You may also access Promethean Cloud Connect from within your Locker.



Your **OneDrive** now displays on the left side of the window. Access images, PDFs, Promethean Whiteboard files, and more.

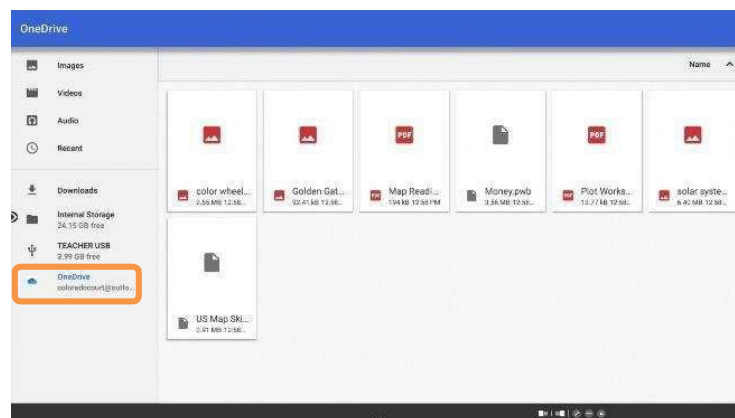

Easily save Promethean Whiteboard files to your connected Google Drive by selecting the **Menu**, then **Save As**.



To change the save location, you may need to select the **three horizontal lines** in the top left corner.

Then, select **OneDrive**.

Give your Whiteboard file a name, then tap the **green checkmark** on the keyboard.

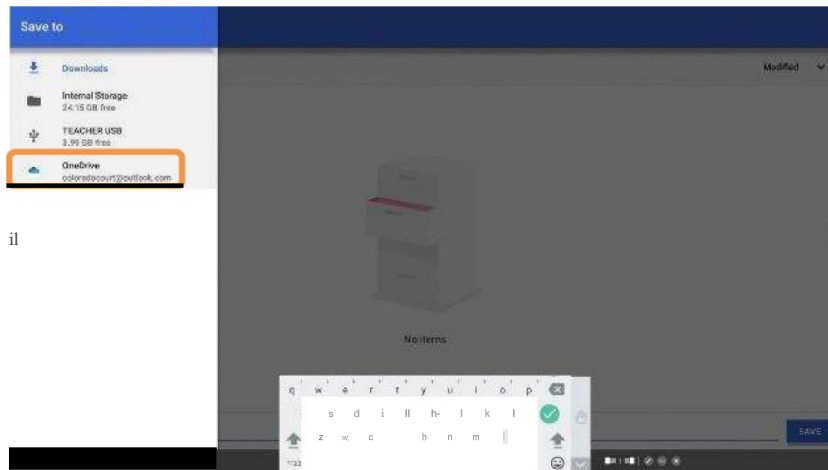

## Promethean Whiteboard App

Access the Promethean Whiteboard App from your **Unified Menu or Locker**. The Whiteboard toolbar resides on the left side of the window by default.

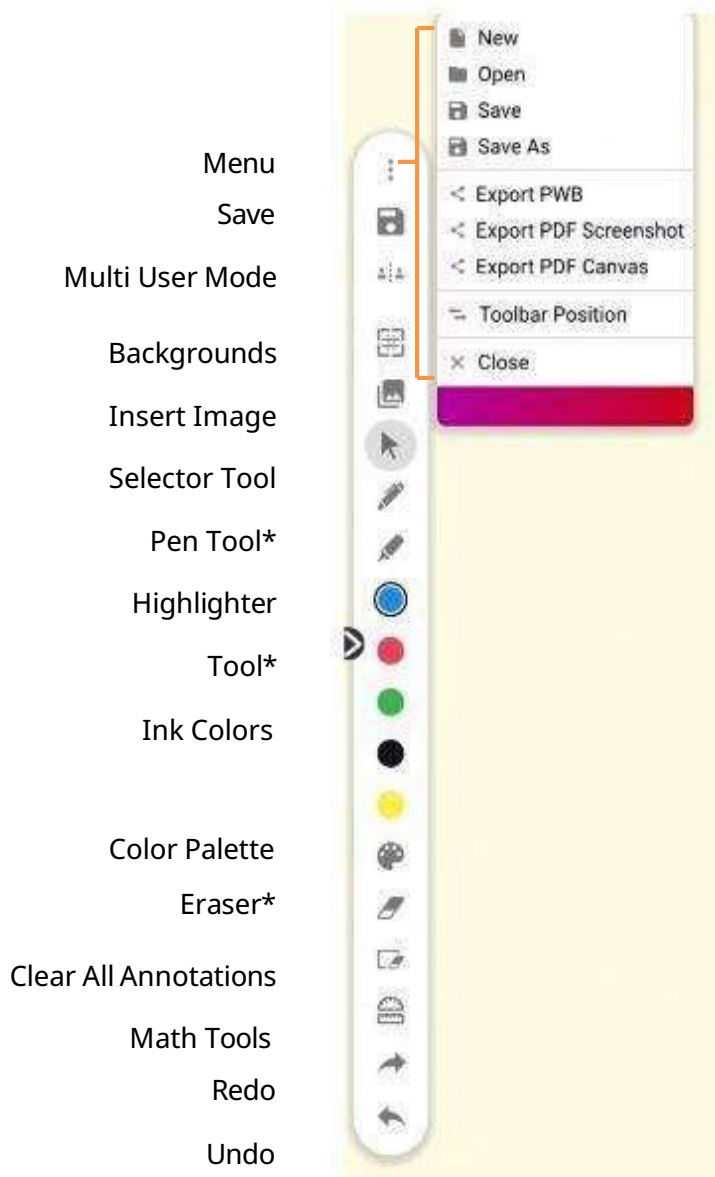

\*Tap once to select the tool and twice to access additional widths.

## Promethean Capture App

The Promethean Capture app allows you to capture and crop anything displayed on your panel's screen, enabling you to organically create lessons and activities.

To use Capture, access the **Unified Menu**, then tap **Capture**.

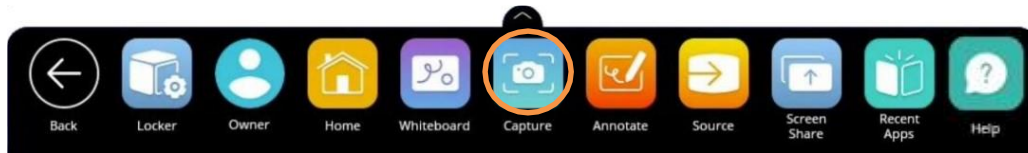

You will see two options: **Open in Whiteboard** or **Close**. To use the entire image, select **Open in Whiteboard**.

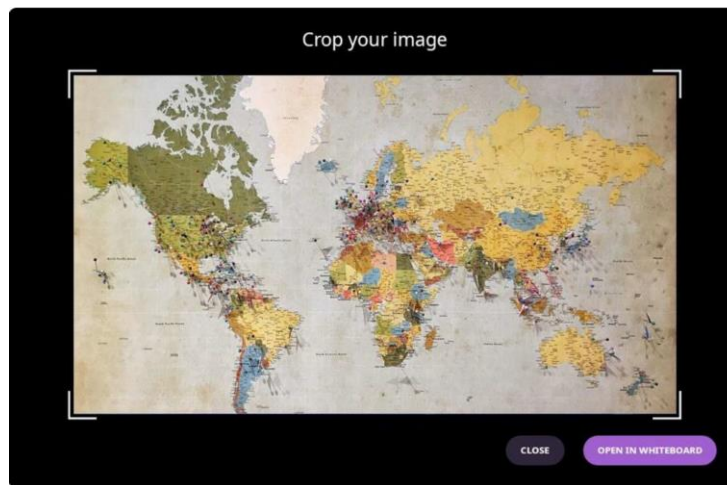

You may move, resize, and rotate the image in Whiteboard as you wish. Add annotations, interact with math tools, and more.

To crop a captured image, access the **Unified Menu**, tap **Capture**, then use the sizing handles to modify the image as you wish. Tap **Done** to finalize cropping.

You will once again have the options to **Open in Whiteboard**, or **Close**. You may wish to save this new Promethean Whiteboard file.

## Promethean Annotate App

The Promethean Annotate App is perfect for adding annotations over anything displaying on your panel's screen, empowering you to make the most of teachable moments. You may also use it over top of connected devices.

To access, tap the **Unified Menu**, then the **Annotate** app. It is also accessible from your **Locker**.



The toolbar appears. You may move it anywhere on your screen and it remembers the last location in which it was docked. The Annotate app allows for different point sizes for the pen, highlighter and eraser simultaneously.

Tapping a color dot allows you to choose a different color from the presets or use a long touch to access the custom color picker.

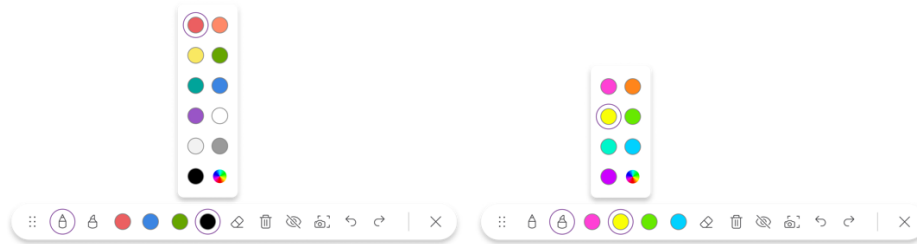

Use the **Eraser** to erase a bit of an annotation or tap the trash can to **Clear All Annotations** and start fresh.

Tap the **eye button** to exit annotate mode and interact with other content on your screen. Tap the **eye button** once more to return to annotate mode and continue annotations.

From the annotate tool bar, you can easily take a **screen capture**. Use the **Undo** and **Redo** buttons to make quick corrections.

Tap the **X** to exit the app. You will be prompted with a message to save your annotations.

## Switching Sources

To access devices connected to your ActivPanel, including a laptop, you may need to switch sources. To switch to another source, tap the **Unified Menu**, then the **Source** button. You also may use the **Source button** on the center console.



Source options will appear. The source currently in use will be highlighted. Tap whichever source you would like switch to.



You may still access the Unified Menu and Classroom Essential Apps over top of connected devices.

To return to your ActivPanel home screen, either tap the **Source** button and select **Home**, or select **Home** from the **Unified Menu**.



## Power On Default Source

If you frequently use connected devices in tandem with your Elements Series ActivPanel, such as a Promethean Chromebox, ActivConnect OPS-G or OPS-M, or even your laptop, you may wish for your panel to automatically launch to that environment. In this case, changing your Power On Default Source will save you valuable time.

To begin, select the **Unified Menu**, then tap **Locker**. Within the Locker, tap the gear icon for **Settings**. Then select **More Settings**.



Next, select **Display**.

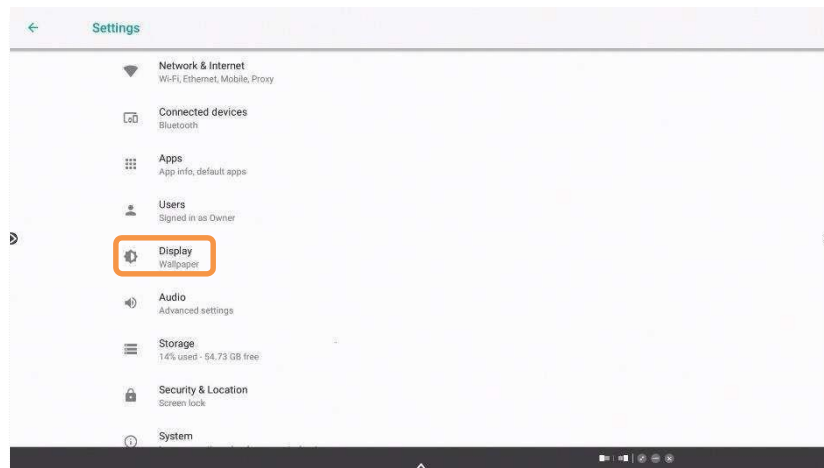

Within Display settings, select **Power On Default Source**.



This will display the locations of currently connected devices. Select whichever source you wish for your ActivPanel to default to when powering on. You may change this setting at any time.

## Promethean Timer App

The Promethean Timer App is perfect for managing activities, assessments, and more within your classroom.

To access, tap the **Unified Menu**, then **Locker**.



Select **Timer** from the Apps tab.

The Timer app opens. There are three modes: Clock, Timer, and Stopwatch. Tap the **gear** to access more options in any mode, like adding celebrations, sounds, color themes, and more.

Tap the **plus sign** to add additional timers, spinners or stopwatches or any combination of these three.

Long touch and move the timer to any location on your screen.

Tap the **magnifying glass** to select one of three sizes or minimize the timer. The timer continues to work while minimized.

Within the Timer mode, choose between **presets** or use the up and down **arrows** to customize your own Timer. Press the **Start** button to initiate. Use the **Pause** and **Reset** buttons as needed.

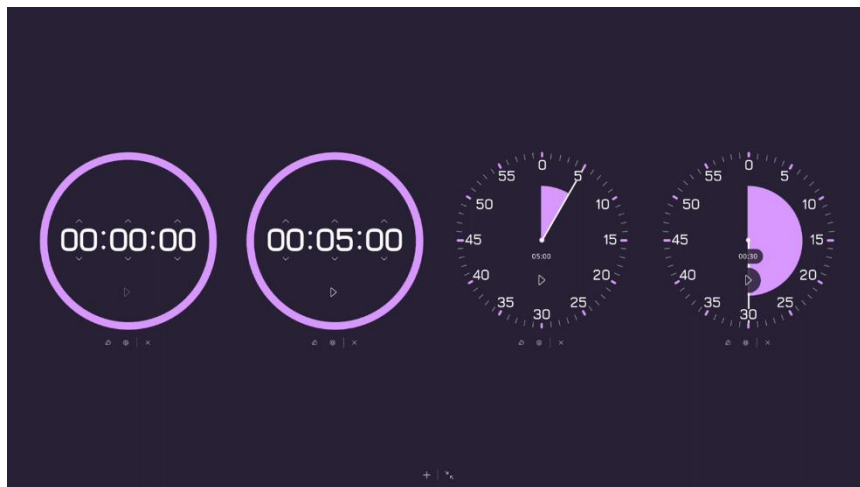

Tap the **X** to close each Clock, Timer, or Stopwatch.

## Promethean Spinner App

The Promethean Spinner App is perfect for quickly and easily randomizing elements for your class all in one place.



To access, select the Unified Menu, then tap Locker. Select **Spinner**.

The Spinner app opens. There are three floating modes, as well as a minimized and full screen mode. You may access these modes through the magnifying glass.

Touching and holding the box around the floating spinner allows you to drag it anywhere on the screen.

The spinner has 3 default lists and allows you to create up to 30 custom lists. Tap the title of the list to select the spinner or create a new list to make one of your own.



You can create a new list by typing in the items directly on the ActivPanel.

Select **Add item** to add additional entries.

When all your items are added, tap **Done** to save or tap **Cancel** to end. You may also import your pre-created lists from a .csv file.

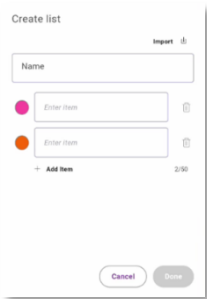

To edit any existing list, simply tap the pencil icon to the right of the list title. Select any item to make changes.

Delete individual lines by tapping the **trash can** or tap **Delete** to delete the list entirely.

Tap the **gear icon** to customize your spinner's settings and styles, like adding celebrations, sounds, and spin duration.

Tap the **plus sign** to add an additional spinner.

To use the Spinner, just drag any segment of the Spinner in a clockwise or counterclockwise direction.

Tap the **X** to exit the Spinner app.

## Promethean Account

Your Promethean account offers new and exciting tools and resources to engage your students. To create a Promethean account, go to [one.prometheanworld.com](http://one.prometheanworld.com).



### Share to a panel

Share your screen on an **ActivPanel**

DOWNLOAD SCREEN SHARE

From your Promethean account, you can easily download Screen Share and share devices to your Elements Series ActivPanel. You can also download the Screen Share app at [share.one.prometheanworld.com](http://share.one.prometheanworld.com)

Within your Promethean account, you have access to thousands of ready-made flipcharts. Select the **Apps** button in the upper right, then **Resource Library**.

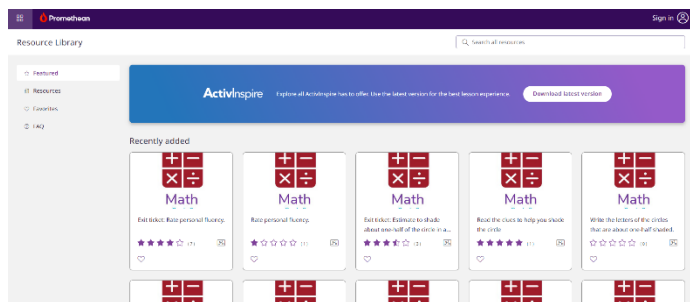

Within the Resource Library, you may **search** for and **preview** flipcharts, and **share** them with your colleagues. By creating a free account and signing in to your Promethean account, you can easily **save** flipcharts to your organized Favorites, or rate the resource.

To extend your learning, explore Learn Promethean resources and video tutorials from within your Promethean account.

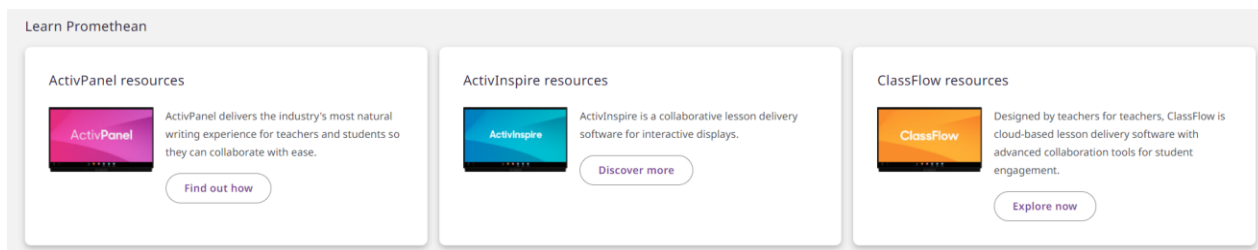

## Promethean Screen Share App: Connecting Devices

The Promethean Screen Share app allows you to quickly connect and mirror student devices and lends itself perfectly to classroom collaboration and student-driven learning.

To begin, please be sure you are using an Elements Series ActivPanel and are running firmware version 3.2 or higher. To update your ActivPanel Titanium's firmware, please visit [support.prometheanworld.com/article/1742/](https://support.prometheanworld.com/article/1742/).

There are three ways you may use to connect using a web-enabled device.



To download the sender for your device, visit [share.one.promethean.com](https://share.one.promethean.com).

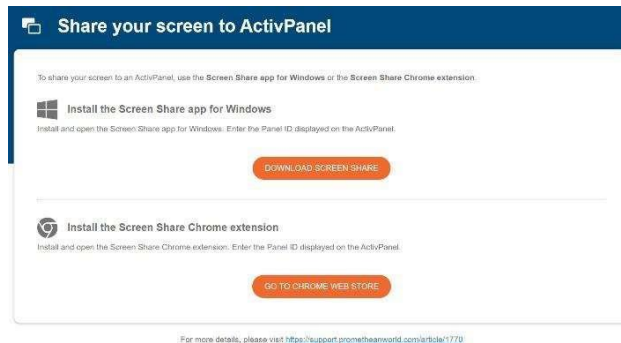

To begin connecting devices, access your **Unified Menu**, then tap **Screen Share**.



A floating window appears. You may move this anywhere on your screen. You may **name** your panel, tap the **reset** button to generate a new 6-digit panel ID, or tap the **people** icon to enter the waiting room.

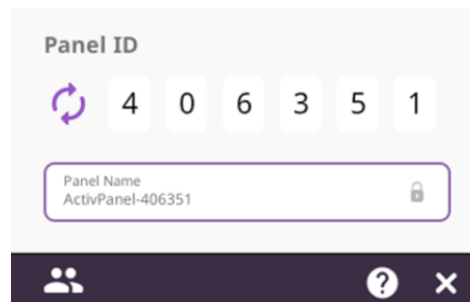

To connect from a computer with the Share Screen Sender, enter the **panel ID**. Next, enter your **name**, and be sure to **enable touchback**. Then select **Enter Waiting Room**.

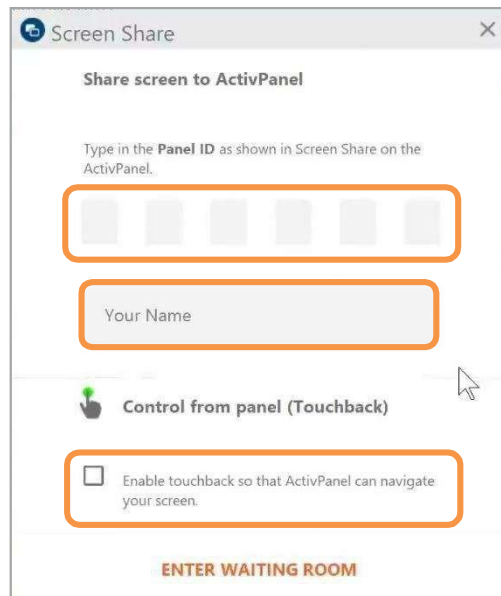

Students will enter the **panel ID** and their **name** within the Chrome extension or the mobile app. Then select **Start Screen Share**. Please note, students can use the screen share mobile app as a guest without signing in.

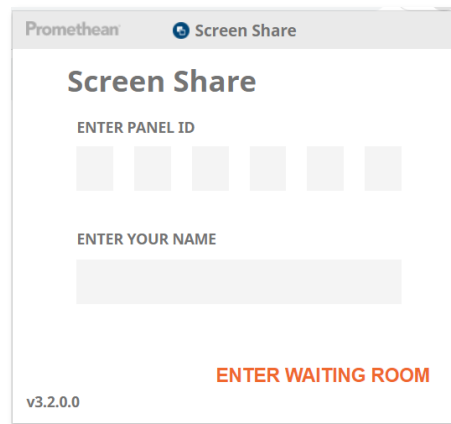

Connected devices will display within the Waiting Room. Tap a student's name to share a single screen or select up to four students to share simultaneously. Once you have selected their names, tap the **Share** button at the bottom of the waiting room window. A purple dot beside a student's name denotes that touchback capabilities are in effect.



Please note: Touchback is currently only available for Windows and Mac devices.

Select any name from the Waiting Room list to mirror this student's device to your ActivPanel. Or tick the boxes next to students' names to mirror up to 4 devices simultaneously. Once you have selected their names, tap the purple **Share** button at the bottom of the Waiting Room window.



To remove a student, simply tap the **X** next to their name. You will be prompted to confirm their removal.

Within the Waiting room, you also may sort students by position or alphabetically.

Tap the circular arrows to **refresh** your Panel ID. This will also disconnect currently connected devices. This may come in handy if you have a new class of students entering the classroom or if you share your classroom with another teacher.

Tap the diagonal arrows to **minimize** the Waiting Room and return to the floating Screen Share window. Tap the people icon to return to the Waiting Room.

Finally, tapping the **X** will result in closing Screen Share and ending the casting session. You will be prompted to confirm your choice.

When a student mirrors their screen with Touchback enabled, their device's screen will be framed in bright green. This is an example of the student's computer screen:



Likewise, when mirroring a student device with Touchback enabled, this screen will also be framed in bright green on your panel, as shown below for the screen in the top left quadrant:



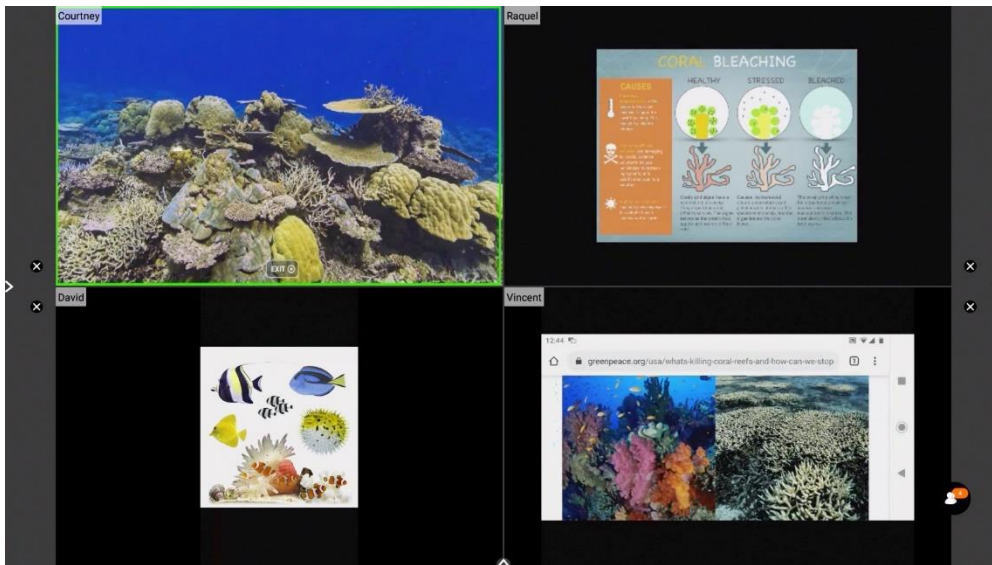

With Touchback enabled, you may navigate connected devices in real time. Possible classroom examples include becoming untethered, sharing applications or programs, allowing students to display work and demonstrate learning, and more.

There are other ways to connect a device to Screen Share.

The Chrome Browser has an app that can be downloaded to applicable devices but does not allow touchback. Download the Chrome extension app from the [chrome web store](#).

To share from the Chrome Extension:

1. Open the Screen Share Chrome™ Extension
2. ENTER PANEL ID
3. ENTER YOUR NAME
4. Click **ENTER WAITING ROOM**
5. Select your screen
6. Tap **Share**

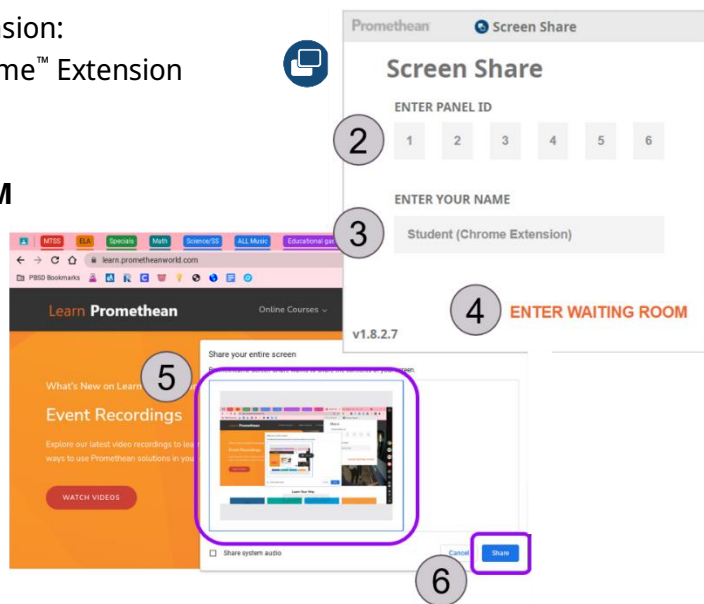

## Promethean Activities Player

The Promethean Activities Player provides an easy way to access your pre-created ActivInspire activities and engage your students on your Elements Series ActivPanel.

Begin by saving the ActivInspire Activity to a USB, then plug the USB into your Elements Series ActivPanel. To access your activity on your ActivPanel, tap the **Unified Menu**, then **Locker**.



Select **Activities** from the Apps Menu.

The Activity Player opens. Recently opened activities will display on the Recent tab. Tap the **diagonal arrows** to maximize or minimize the Activity Player.

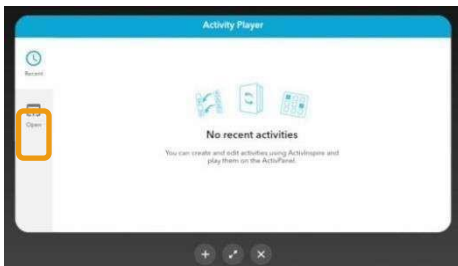

Tap **Open** to access an activity from your USB.



Tap the **three horizontal lines** in the top left corner and locate your USB. Next, select an Activity.

Two activities may be open at once for a multi-user experience. Tap the **plus sign** to open a second activity. It could be the same activity, or a different one. Multiple students can practice skills and concepts simultaneously.

Tap the **X** to close an activity. Once you close the final activity, you'll be returned to the main window. Tap the **X** once more to return to the home screen.

## Recent Apps

The Recent Apps button within the Locker allows you to easily toggle between various apps on your ActivPanel. To access Recent Apps, select the **Unified Menu**, then tap **Recent Apps**.



This displays all of your recently opened applications, including apps from connected devices such as an ActivConnect OPS-G.

Depending on how many apps you currently have open, there may be multiple pages, denoted by small white dots at the bottom of the Recent Apps window. Swipe to the **right or left** to navigate between pages.

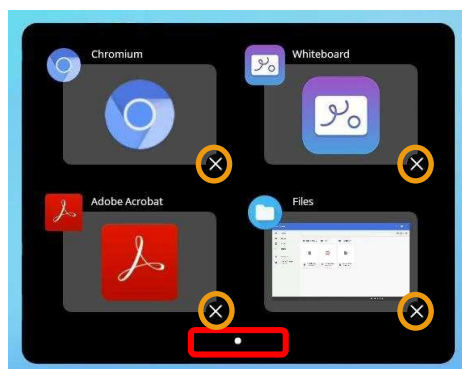

To return to any of these open apps, simply select the **app**.

To close apps, much like you do on your smart phone, simply tap the little **x** to the bottom right of an app.

## Managing Apps

To manage apps installed on your Elements Series ActivPanel, for instance changing notification settings, select the **Unified Menu**, then tap **Locker**.



Select the **gear** icon to access Settings. Tap **More Settings**.

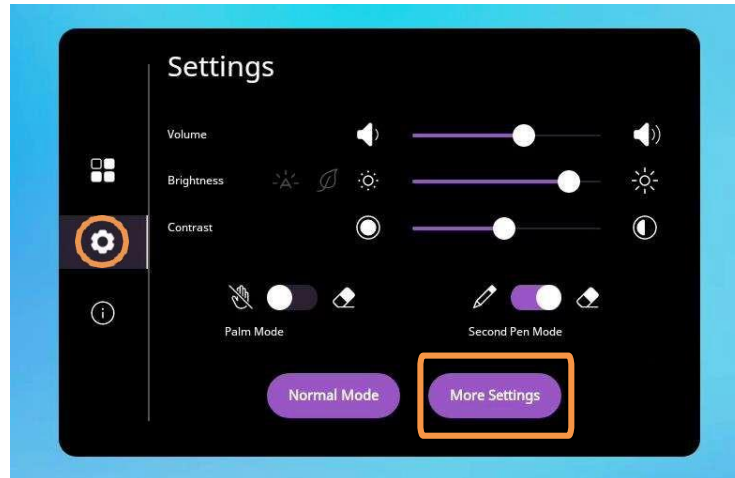

Select **Apps** from the Settings menu.

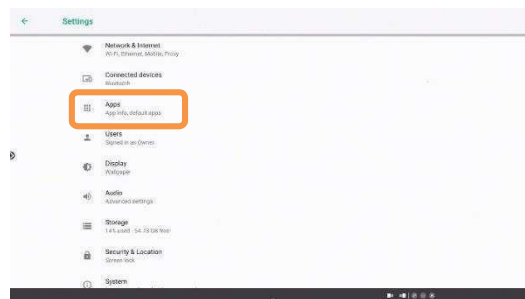

Your apps are listed alphabetically. Scroll to the desired app you wish to view in more detail and tap its **title**.

On the App Info screen, you may need to scroll down to view all of the app's information.

Tap the back arrow in the top left corner to return to your list of apps. Alternatively, you can tap the **Home button** from the **Unified Menu** to return to the home screen.

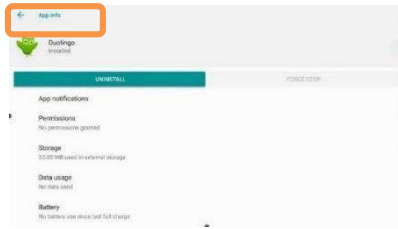

## Locating Apps

The **Locker** houses all your apps, including those from connected devices such as a Promethean Chromebox or ActivConnect OPS-G.

To locate apps, access the **Unified Menu** and tap **Locker**.



The Locker will automatically open to the **Apps** tab, but you also can access it by tapping the **cube icon** to access Apps.

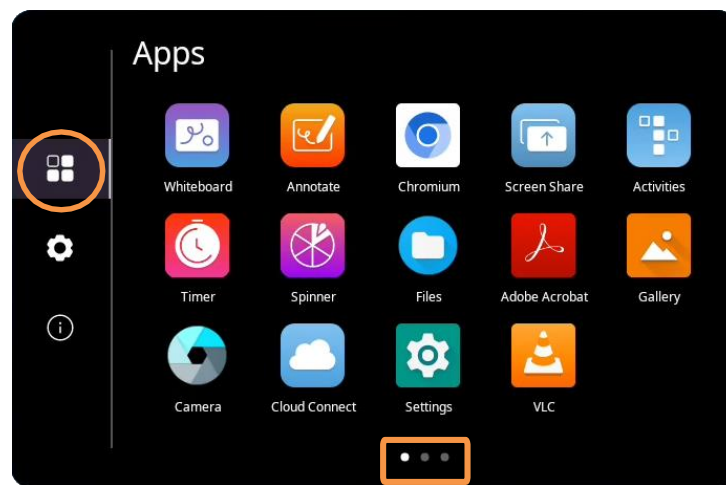

Depending on the number of apps you have installed, there may be more than one page. Pages are denoted by small white dots at the bottom of the Locker window. **Swipe right or left** to navigate between these pages.

## Rearranging Apps

You may rearrange your installed apps within the Locker for quick access and to best accommodate your teaching.

To rearrange apps, access the **Unified Menu** and tap **Locker**.



The Locker will automatically open to the **Apps** tab, but you also can access it by tapping the **cube icon** to access Apps.

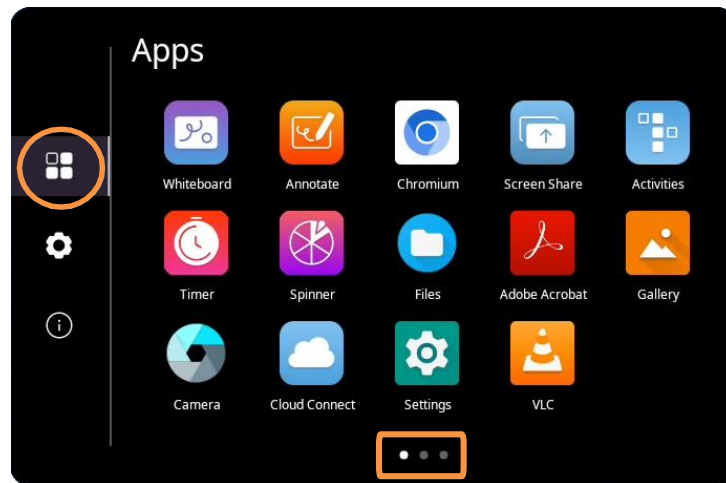

Depending on the number of apps you have installed, there may be more than one page. Pages are denoted by small white dots at the bottom of the Locker window. **Swipe right or left** to navigate between these pages.

To rearrange your apps, much as you do with your smart phone, simply press and hold the app while you drag it to the desired location. You may move an app to a new location within a page, or to another page.

To create a new page within the Apps tab of your Locker, simply drag an app icon onto a page that is fully populated. Organize your apps by function, subject area, apps for student use, and more!



## Closing Apps

To close apps on your Elements Series ActivPanel, select the **Unified Menu**, then tap **Recent Apps**.



Depending on how many apps you currently have open, there may be multiple pages, denoted by small white dots at the bottom of the Recent Apps window. Swipe to the **right or left** to navigate between pages.

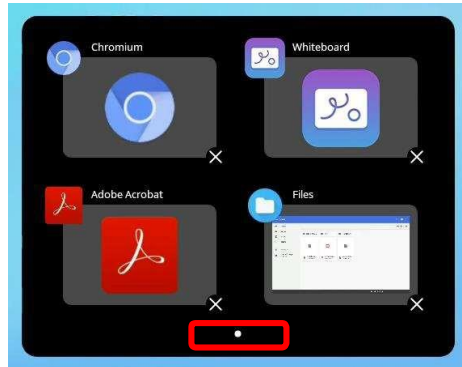

To close apps, much like you do on your smart phone, simply tap the little **x** to the bottom right of an app.

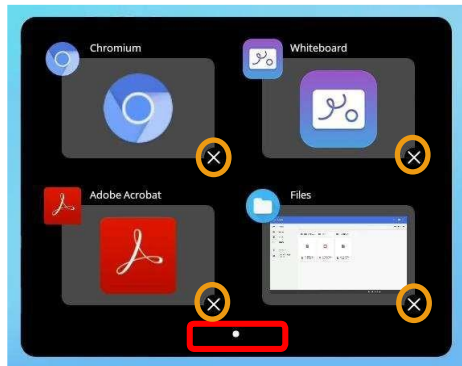

## Uninstalling Apps

To uninstall apps from your Elements Series ActivPanel, select the **Unified Menu**, then tap **Locker**.



Select the **gear** icon to access Settings. Tap **More Settings**.

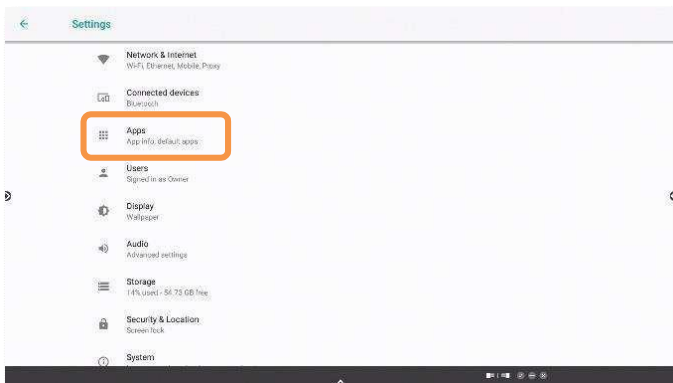
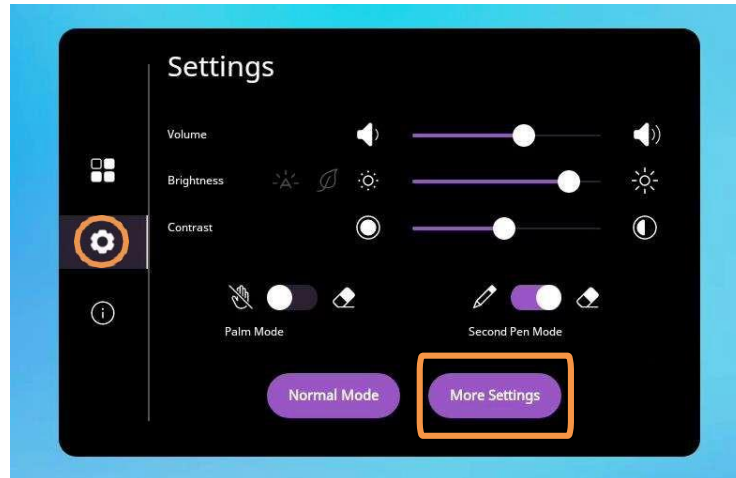

Select **Apps** from the Settings menu.

Your apps are listed alphabetically. Scroll to the desired app you wish to uninstall and tap its **title**.

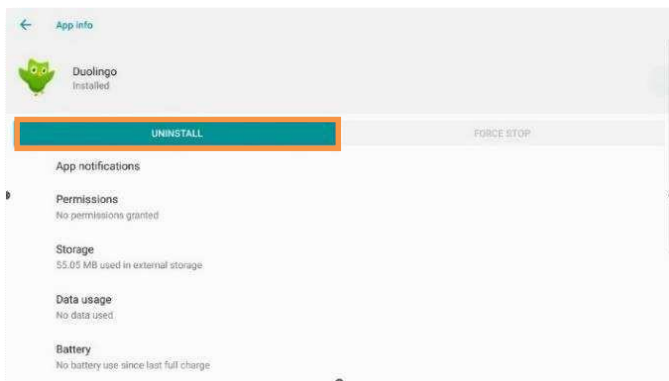

Tap the **Uninstall** button to begin the uninstallation process.

You may be prompted once more to confirm your choice to uninstall.

Once uninstallation is complete, you will briefly receive a small confirmation at the bottom of your screen and will be returned to the app list.

## Accessing Content from Your USB and Downloading Files

There are a few ways to access files on your ActivPanel. This method describes accessing content from a USB by using the Files app from the Apps tab in the Locker, then copying, or downloading, that content to the ActivPanel.

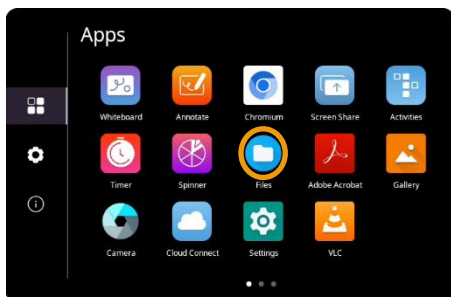

First, insert your USB into one of the USB ports on your ActivPanel. Next, go the **Unified Menu** and tap **Locker**. In the Locker on the Apps tab, you will see an app titled **Files**. Select it.

This takes you to a Downloads window. Access your USB by selecting it on the left.

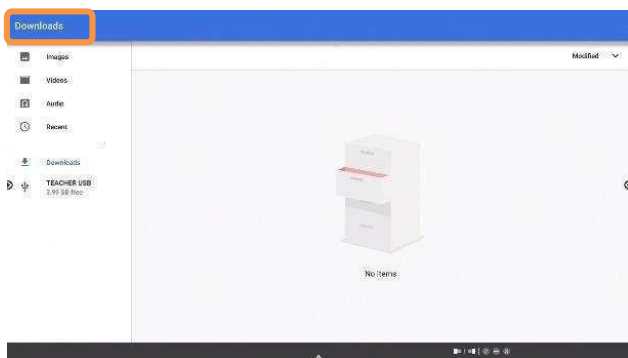

You will see the content from your USB listed here. Press any file for two seconds to select it. Once one file is selected, you may select additional files simply by tapping them.

Once one or more files is selected, tap the **three vertical dots** in the top right corner. To download these selected files to your ActivPanel, choose **Copy to...** from the menu that appears.

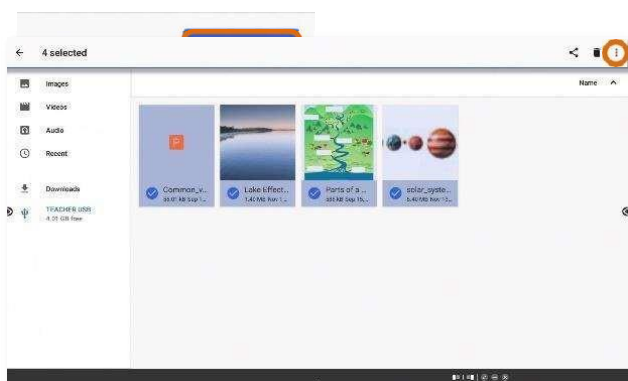

The Downloads screen reappears, this time with options in the bottom right corner. Select the blue **Copy** button.

You will be returned to your USB. To confirm that your files were downloaded successfully, select **Downloads**.

## Creating Bookmarks in the Chromium Browser

To bookmark your favorite websites for easy access in the preinstalled Chromium browser, begin by selecting the **Unified Menu**, then tap **Locker**. In the Locker, select the **Chromium** app.

Enter or search for the URL you wish to bookmark. Select the **star** icon to the right of the URL you entered. This bookmarks your page.

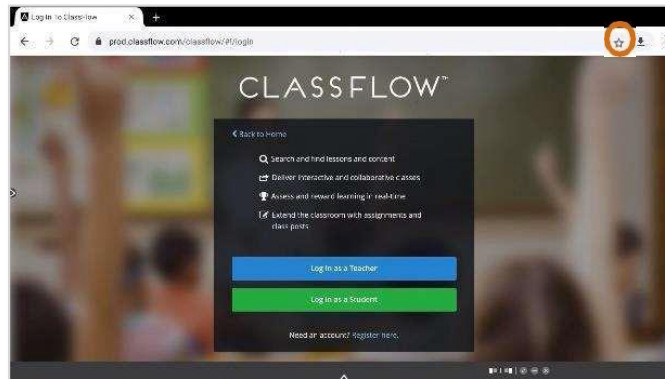

You will receive a brief confirmation at the bottom of the screen that the website has been bookmarked and the star will turn blue.

Tap the **three vertical dots** in the top right, then select **Bookmarks** to modify your existing bookmarks. You may edit bookmarks, move them into folders, and delete them.



To visit a bookmarked website, tap the website that appears. Then, tap the **three vertical dots** on the blue header to reveal options.

## Connecting a Laptop to Your ActivPanel

To connect your laptop to your ActivPanel, begin with either a VGA or HDMI cable and a USB cable. The VGA or HDMI enables a visual connection, while the USB cable enables touch.



VGA



HDMI



USB

Ports on your ActivPanel are clearly labeled.

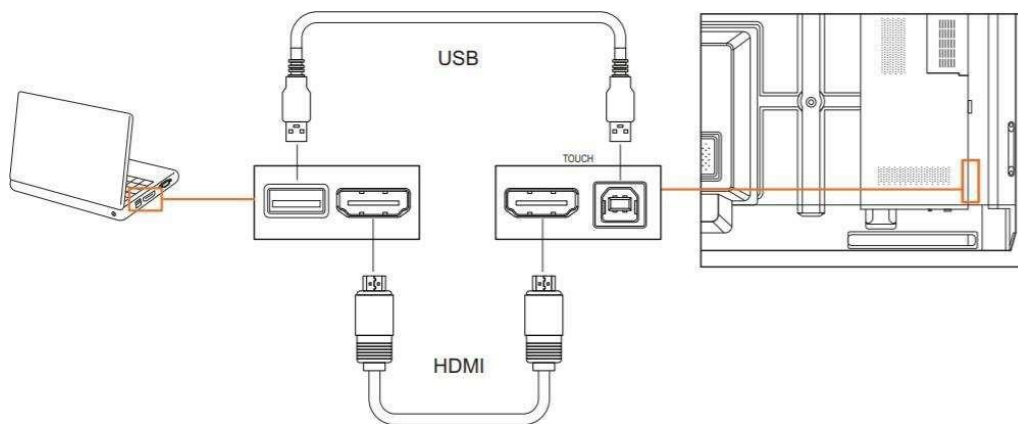

If you are connecting a Mac to your ActivPanel using a VGA cable, you may need an additional adapter or dongle. You may also require an audio cable.



Elements Series ActivPanels feature easily accessible front ports.

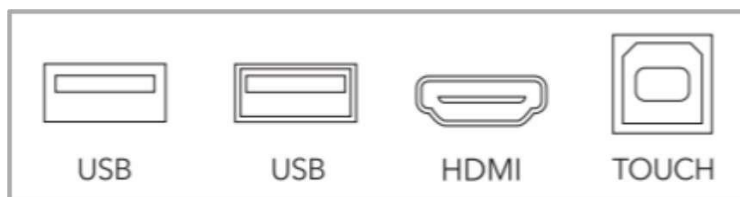

You will find additional ports on the back of your ActivPanel. When facing the panel, they are on the left side. Be sure to connect HDMI and USB cables into their corresponding ports. For example, use **HDMI 2** in tandem with **TOUCH 2**.

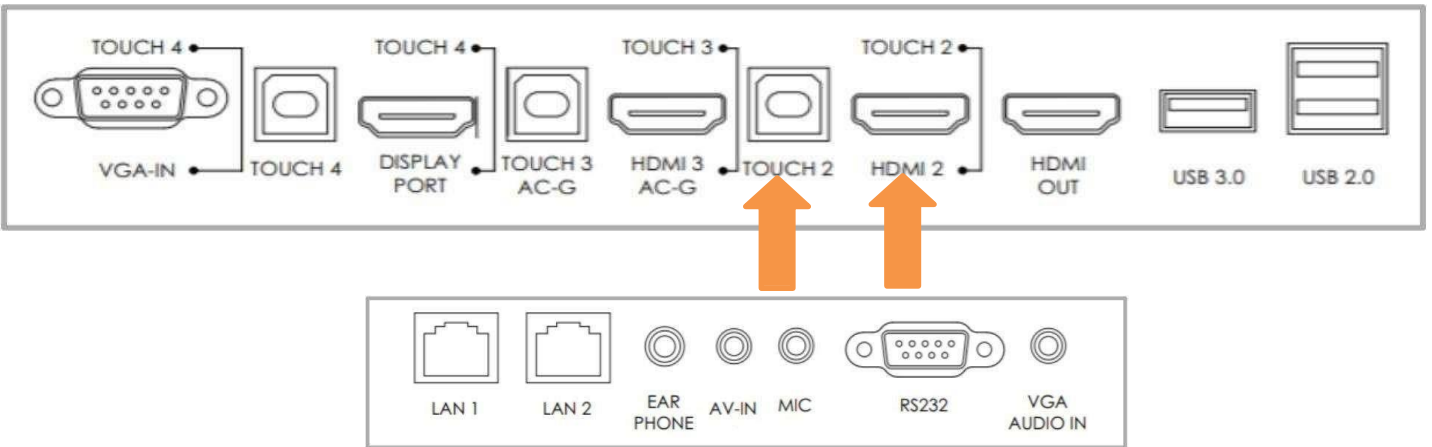

Once you have connected, access the **Unified Menu** and tap **Source** to toggle over to your computer. On an ActivPanel Titanium, you may also use the **Source** button on your **Center Console**.



Remember, you always have access to the Unified Menu, even over connected devices. This means you will also have access to the Classroom Essential Apps.

Use the **Home** button from the **Unified Menu** to return Home at any time.

For more information or to receive assistance, please visit [support.prometheanworld.com](https://support.prometheanworld.com).

## Connecting an ActivConnect OPS-G to Your ActivPanel

*Your district may have chosen additional connected devices for your ActivPanel .*

To connect your ActivConnect OPS-G to your ActivPanel, begin by ensuring you are running the most up-to-date firmware. Please visit [support.prometheanworld.com/update](https://support.prometheanworld.com/update) and/or [support.prometheanworld.com/article/1742/](https://support.prometheanworld.com/article/1742/) for more information.

Install the ActivConnect OPS-G in the OPS slot on the side of the ActivPanel. Next, ensure your ActivConnect OPS-G is ready to connect to your ActivPanel. Visit [support.prometheanworld.com/article/1753](https://support.prometheanworld.com/article/1753) for more information.



Access the **Unified Menu** and tap **Source**. Select **OPS** to switch over to your ActivConnect OPS-G.



You will want to ensure your ActivPanel and ActivConnect OPS-G are connected to the same internet network.

Next, locate your ActivPanel's serial number by opening the **Unified Menu**, then the **Locker**. Select the **Update** icon from the apps tab in the locker. Make note of the serial number which is found at the bottom left corner of the Update window.

Open the **Unified Menu** once more and tap **Source**, then select **OPS** to return to the ActivConnect OPS-G.

Swipe down from the **top** of the screen to display notifications and tap on the notification that reads "**Cannot find Panel Serial number in...**"





Enter the ActivPanel's serial number and tap **OK**. The serial number is not case sensitive.

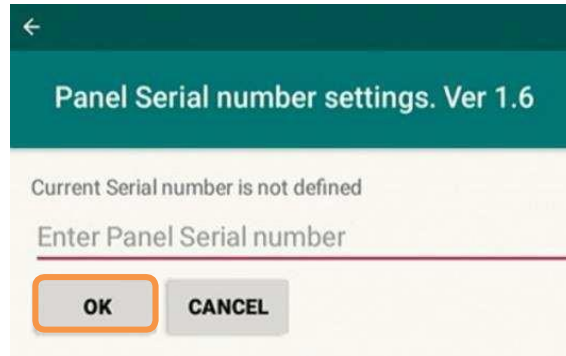

The ActivConnect OPS-G screen will update. The app bubbles and the pink menu button on the home page will disappear.

You can confirm that the integration is complete by swiping down from the top of the screen and the notification will now read "Connected IP..."

From now on, all apps installed on the OPS-G can now be found within the Locker for easy access. For

more information or to receive assistance, please visit [support.prometheanworld.com](http://support.prometheanworld.com).



## Connecting a Promethean Chromebox to Your ActivPanel

Your district may have chosen additional connected devices for your ActivPanel..

To connect your Promethean Chromebox to your ActivPanel, begin by ensuring you are running the most up-to-date firmware. Please visit [support.prometheanworld.com/update](https://support.prometheanworld.com/update) and/or [support.prometheanworld.com/article/1742](https://support.prometheanworld.com/article/1742) for more information.

Connect your HDMI and USB cables to the **HDMI 2** and **USB 2** ports.

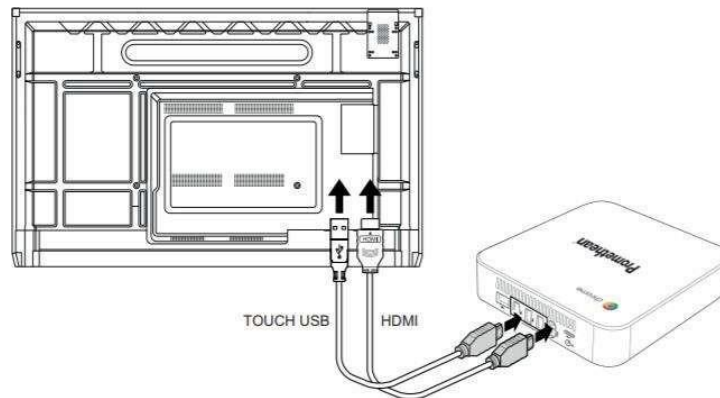

Plug in the power cable and power your Chromebox **on**. You will also need a Google account.

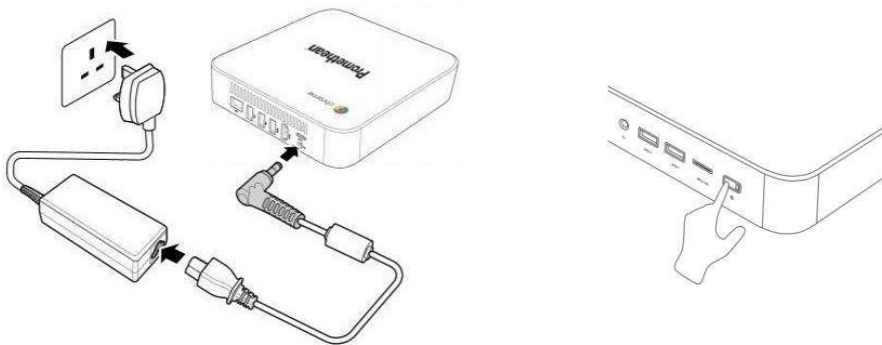

Access the **Unified Menu** and tap **Source**. Select **HDMI2** to switch over to your Chromebox.





Tap in the **bottom right** of the Chromebox desktop to access some basic settings. You will want to ensure your ActivPanel and Chromebox are connected to the same internet network.



## Help and Support

To contact Promethean Support, visit [support.prometheanworld.com](https://support.prometheanworld.com).

## Learn Promethean

To learn more about the ActivPanel and other Promethean solutions:

- Follow us on Twitter [@Promethean](https://twitter.com/Promethean)
- Subscribe to our YouTube channel, [PrometheanVideo](https://www.youtube.com/PrometheanVideo)
- Visit our [Learn Promethean website](https://www.prometheanworld.com/learn) to explore courses, video tutorials, resources, and more

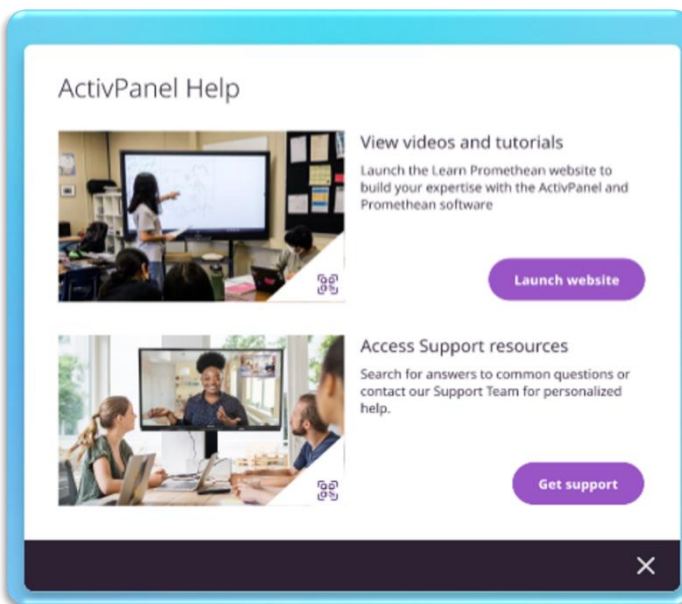

The Help App allows you quick access to hundreds of curated materials found on Learn Promethean and Promethean Support.

To access Learn Promethean with courses, downloadable resources, videos, and blog posts, click Launch website or scan the QR code with your mobile device.

To access Promethean support resources, with software downloads and resources for current and legacy products, click Launch website or scan the QR code with your mobile device. Please follow your district or school policy for contacting a Promethean support representative.